



# KRĒTUS

*systems*



**THOUGHTFULLY DESIGNED COATINGS**

# THE *world* IS CHANGING: HOW CAN *coatings* KEEP UP?

Today's world is unpredictable. Regulations, budgets, environmental conditions, and deadlines shift without warning. That's why we make **high-performance** coatings that adapt to your needs, regardless of the circumstances.

Satisfy USDA, FDA, EPA, and SCAQMD VOC Requirements  
Meet LEED v4.1 Indoor Air Quality Standards  
Increase Protection and Longevity With Premium Options



Our team of experts works closely with you to **make every installation a success.**



Receive On-the-Job Assistance  
Watch and Attend Technical Training Videos and Classes  
Customize with Unique Colors and Formulations

## *Kretus* THOUGHTFULLY DESIGNED COATINGS

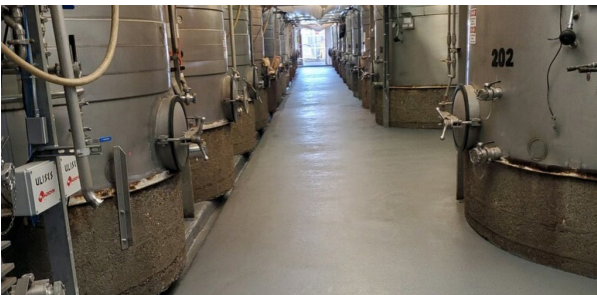

**Innovative:** Ever Developing New Technologies  
**Adaptable:** Mix-and-Match Product Lines  
**Fast:** Quick Turnaround without Compromising Quality

Contact a **KRETUS**® representative today to see what **amazing** things we can create **together.**



# FIND US *online!*

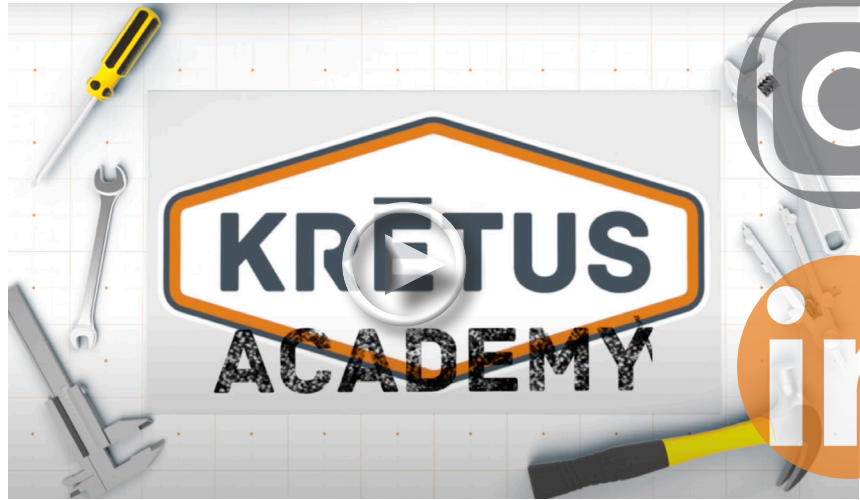

**If you're into games, memes, and jobsite pics:**  
Find us on Instagram, Facebook, and LinkedIn.

**For installation tips, tricks, and more:**  
Subscribe to our newsletter and YouTube channel.

## TABLE OF *contents*

Color Chip.....	4
Metallic.....	5
Color Quartz.....	6
Industrial Sand .....	7
Color Splash.....	8
Cove.....	9
EcoMagnetic™.....	10
ESD.....	11
Waterproofing and Concrete Overlays .....	12
Top Coat Applications .....	14



Scan **QR codes** to learn more about the featured product or system.



[kretus.com/home](http://kretus.com/home)

# COLOR CHIP

*system*

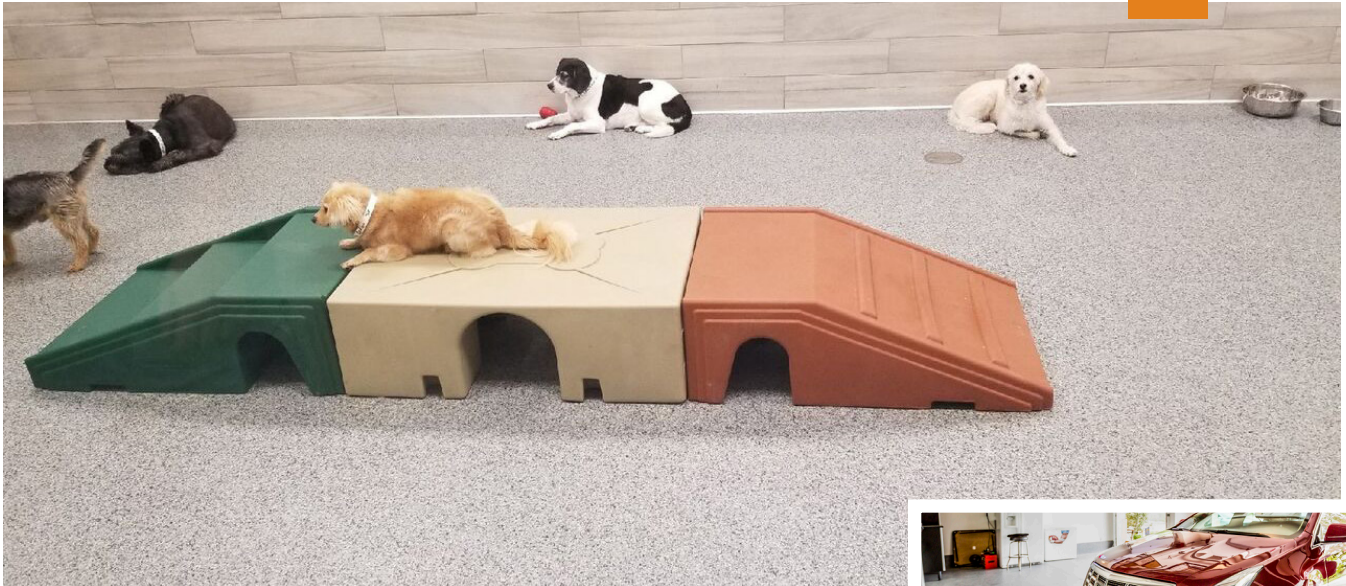

**KRETUS® COLOR CHIP SYSTEMS** stand up to continuous heavy traffic and are great for high-use spaces. They camouflage day-to-day dust and debris, improve slip resistance, and add vibrant or soft color to any room.

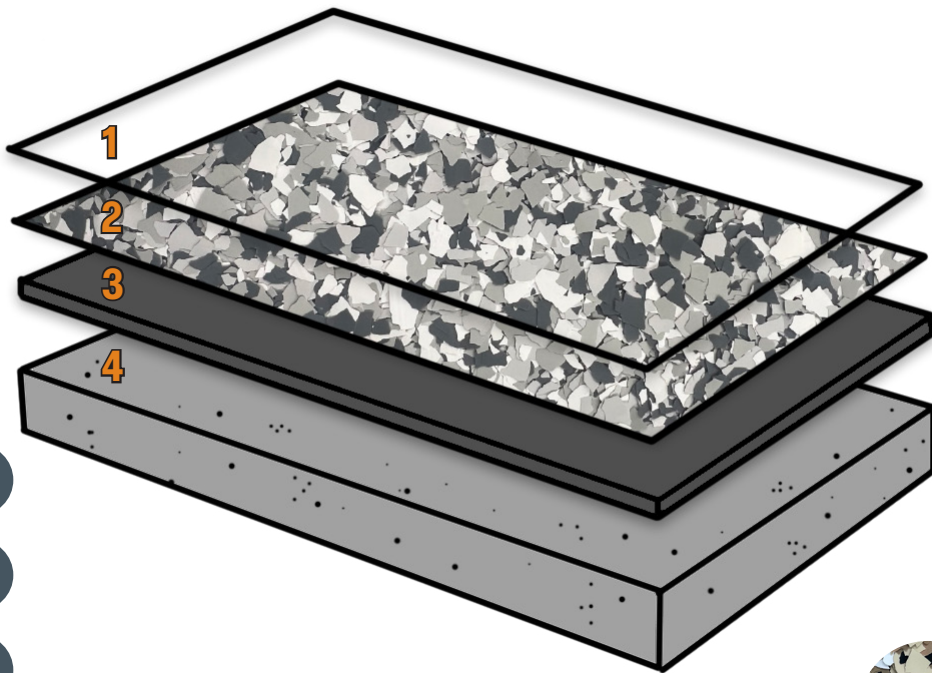

- 1** top coat
- 2** color chip broadcast
- 3** base coat
- 4** concrete profiled to CSP3

## GREAT FOR

- animal facilities
- brand-color matching
- garages
- laboratories
- office spaces

## POPULAR COLORS



CANYON

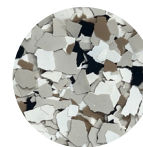

CARAMEL



COOL MIST

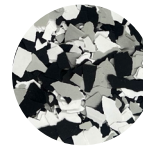

PEPPERMILL

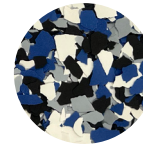

SAPPHIRE

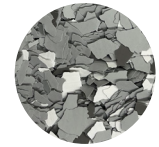

SMOKE

Colors shown are approximate.



kretus.com/  
color-chip



# METALLIC *system*



Turn floors into fine art with **KRETUS TOP SHELF® METALLIC SYSTEMS**. These luxurious 3-D systems combine the strength of our Top Shelf® Epoxy, the longevity of Polyurethane HS (High Shine), and the brilliance of reflective glass for a floor that's beautiful, built to last, and easy to clean.

## GREAT FOR

- showrooms
- shopping malls
- tattoo parlors
- residential garages
- hair salons

## CREATE TRULY *unique* FLOORS

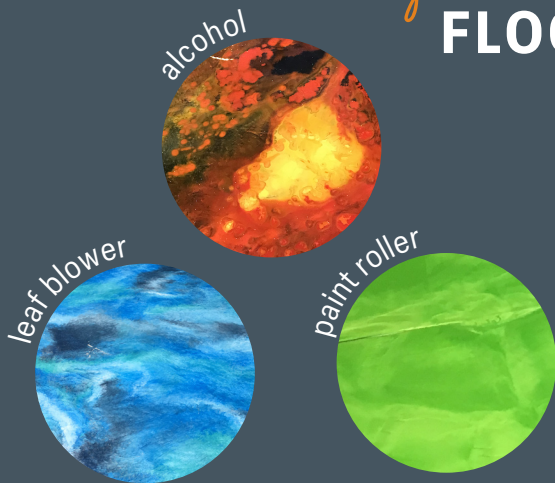

Each floor has an authentic design based on the techniques and artistry of the installer.

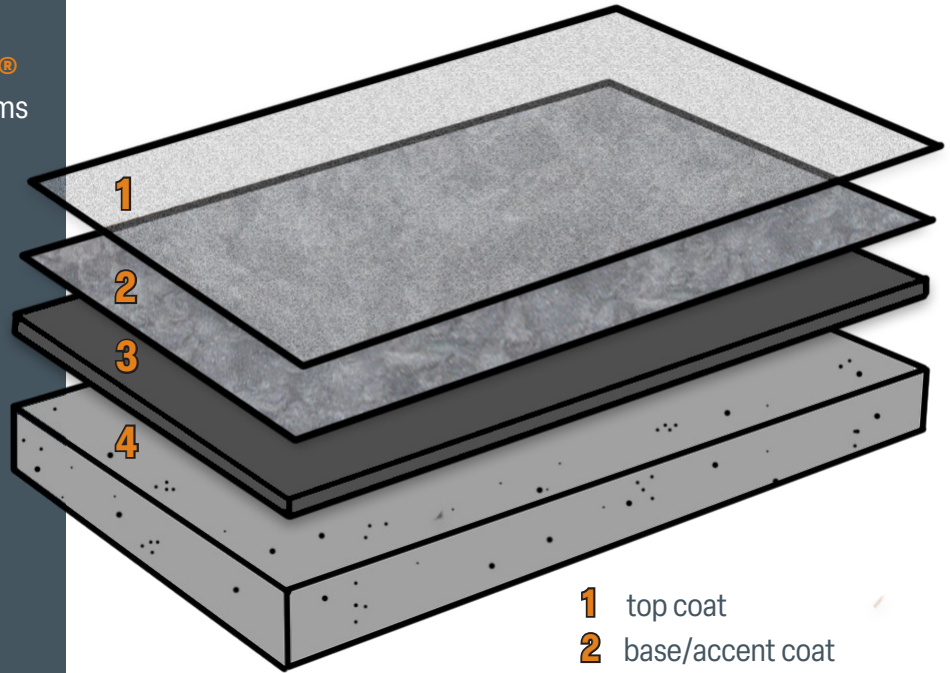

- 1 top coat
- 2 base/accent coat
- 3 prime coat
- 4 concrete profiled to CSP3

## POPULAR COLORS

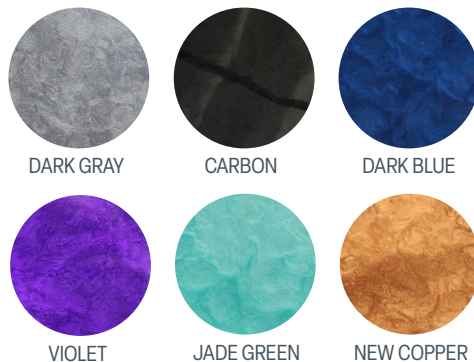

Colors shown are approximate. More options available online.



[kretus.com/metallic](http://kretus.com/metallic)



# COLOR QUARTZ

*system*

Beautiful and exceptionally durable, **KRETUS® COLOR QUARTZ SYSTEMS** offer slip-resistant, hygienic, and easy-to-clean flooring solutions. They can be installed in hot or cold climates, under tight deadlines, and over repaired concrete. While they perform identically to KRETUS® Industrial Sand systems, color quartz offers endless design possibilities by incorporating custom pigmented quartz blends.

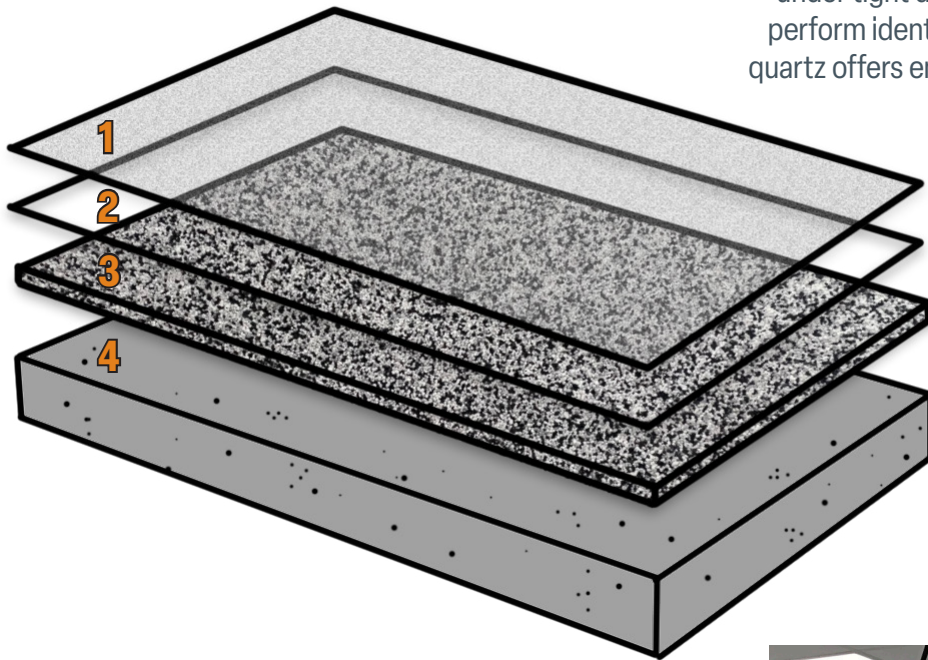

- 1** top coat
- 2** cap coat
- 3** quartz broadcast over base coat
- 4** concrete profiled to CSP3

## POPULAR COLORS



SALT & PEPPER



CINNAMON



BISCUIT

Colors shown are approximate.

## GREAT FOR

- brand color-matching
- dealership floors
- show kitchens
- sports arenas
- decorative warehouse spaces



[kretus.com/  
color-quartz](http://kretus.com/color-quartz)



# INDUSTRIAL SAND

*system*



**KRETUS® INDUSTRIAL SAND SYSTEMS** provide seamless wall-to-floor protection against moisture intrusion, UV degradation, and bacterial and fungal growth. Each system offers fast- and slow-cure options that give skilled installers the ability to take on ever-changing environments, budgets, and deadlines.

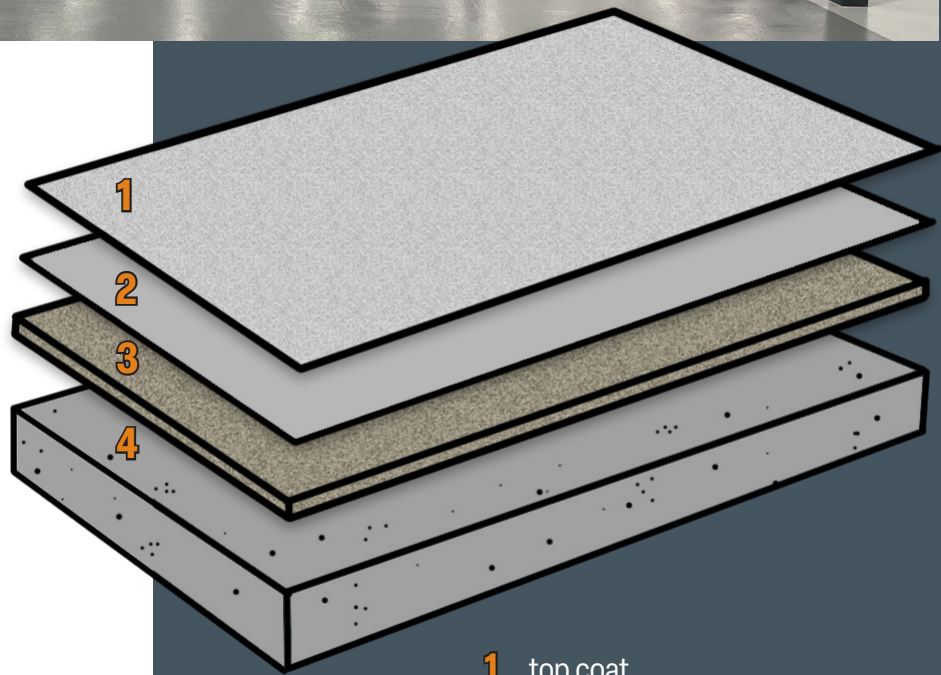

## POPULAR COLORS

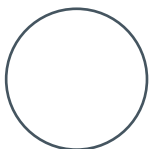

WHITE



SHADOW GRAY



LIGHT GRAY

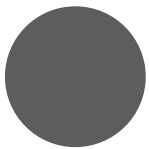

MEDIUM GRAY

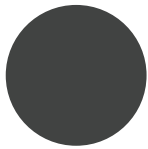

DARK GRAY



SAFETY RED

Colors shown are approximate.  
More options available online.

- 1 top coat
- 2 cap coat
- 3 sand broadcast over base coat
- 4 concrete profiled to CSP3

## GREAT FOR

- food and beverage processing
- heavy-use industrial spaces
- manufacturing and production
- municipal buildings
- water treatment facilities



[kretus.com/  
industrial-sand](https://kretus.com/industrial-sand)

# COLOR SPLASH

*sealer system*



Efficient and easy to apply, these systems add a pop of color to architecture restoration projects, interior design, warehouse walls and floors, and more.

*epoxy • acrylic • poly • upc*

Enhance a structure's natural color and features in clear gloss or cover walls and floors in warm or cool tones with **KRETUS® COLOR SPLASH SEALER SYSTEMS**. Available in Acrylic, Epoxy, Poly, or UPC (Urethane Polymer Concrete), KRETUS® Color Splash protects concrete, wood, drywall, and masonry from minor scratches, bacterial and fungal growth, UV degradation, and water intrusion in just 3 coats.

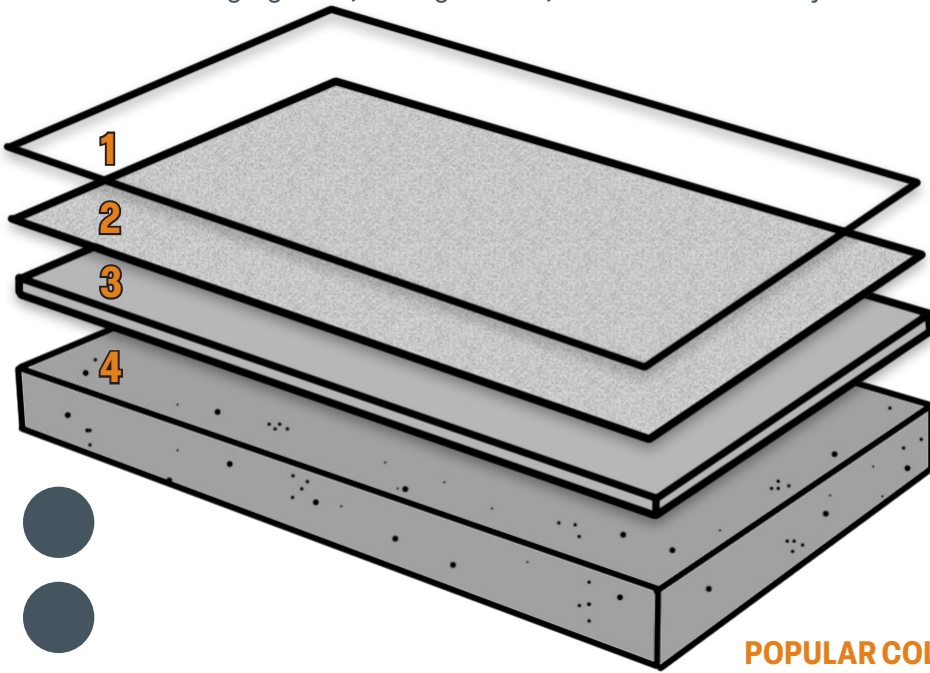
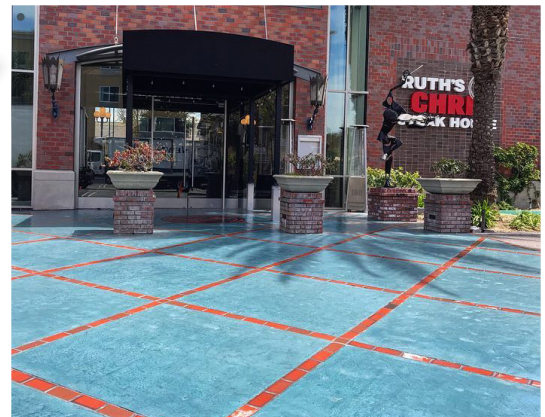

- 1 coat 3
- 2 coat 2
- 3 coat 1
- 4 concrete profiled to CSP3

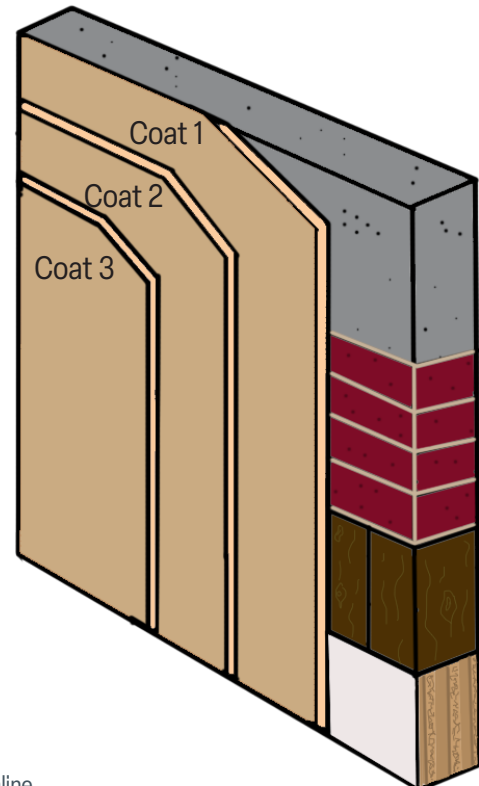

## POPULAR COLORS

### GREAT FOR

- aircraft hangars
- parking structures and drive aprons
- economical walls and floors
- laboratories
- pool decks

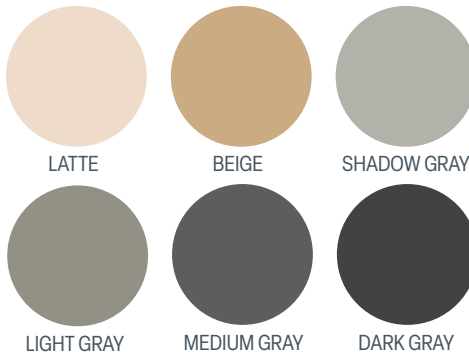

[kretus.com/color-splash](http://kretus.com/color-splash)

Colors shown are approximate. More options available online.



# COVE *system*

Consider **KRETUS® EPOXY AND UPC COVE SYSTEMS** for seamless transitions between walls and floors. They come in a variety of colors, finishes, and heights, and have multiple coating and hardener selections to fit your needs, budget, and timeline.

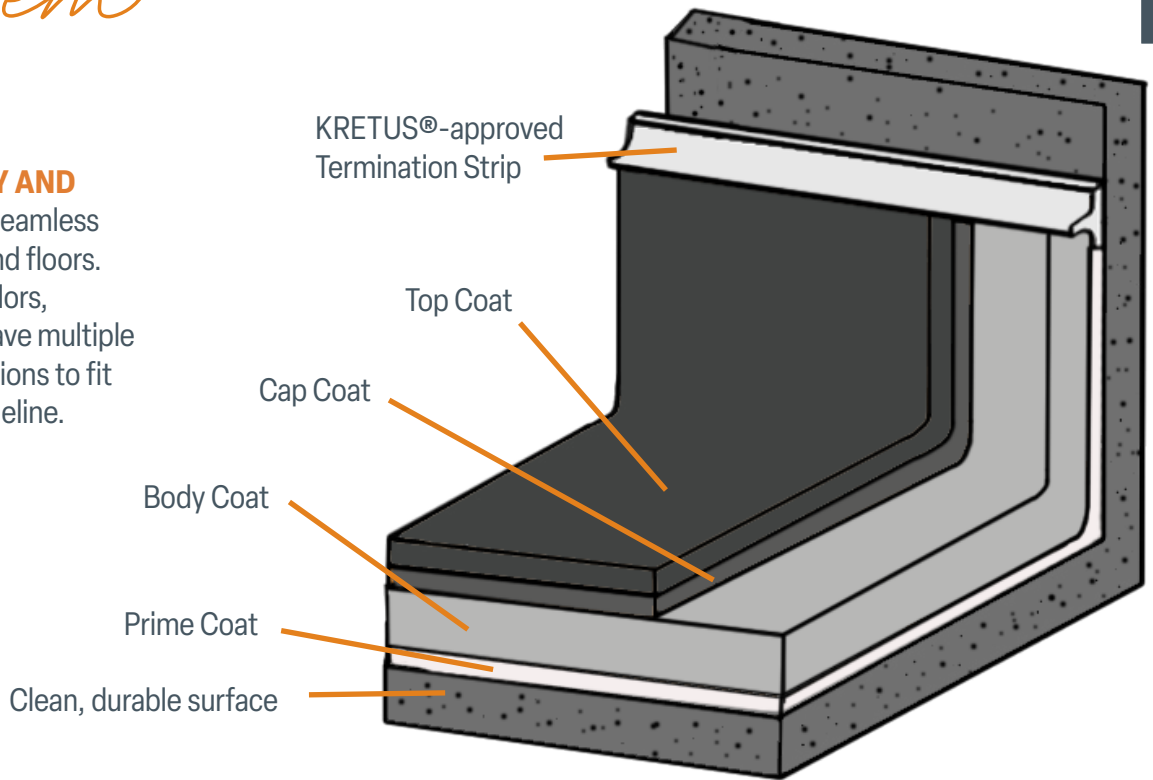

## GREAT FOR

- food and beverage processing
- heavy-use industrial spaces
- manufacturing and production
- municipal buildings
- water treatment facilities

## POPULAR COLORS

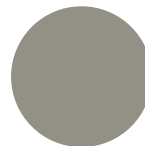

LIGHT GRAY

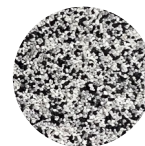

SALT & PEPPER

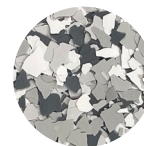

COOL MIST

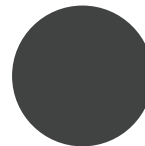

DARK GRAY

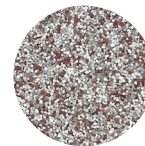

CINNAMON

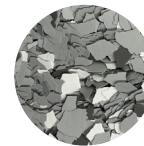

SMOKE

Colors shown are approximate.  
More options available online.



kretus.com/  
cove

# ECOMAGNETIC™ *system*

Experience the future of tile installation with **KRETUS®** **ECOMAGNETIC™**—a revolutionary system that eliminates the need for adhesives. The innovative system harnesses the power of magnets, making it incredibly easy to use on nearly any surface. Featuring reusable magnetic tabs that maintain their stickiness, you'll never have to worry about damaging your tiles or leaving behind any residue.

Resilient Tile:  
EcoMagnetic™ Tabs can transform non-magnetic flooring such as carpet, LVT, ceramic, timber, or other resilient tiles into magnetic flooring.

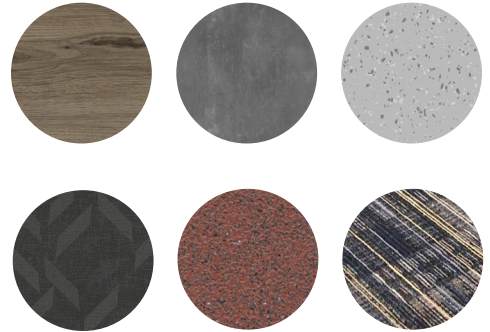

Resilient tile shown as example only.  
KRETUS® does not manufacture or distribute tile.

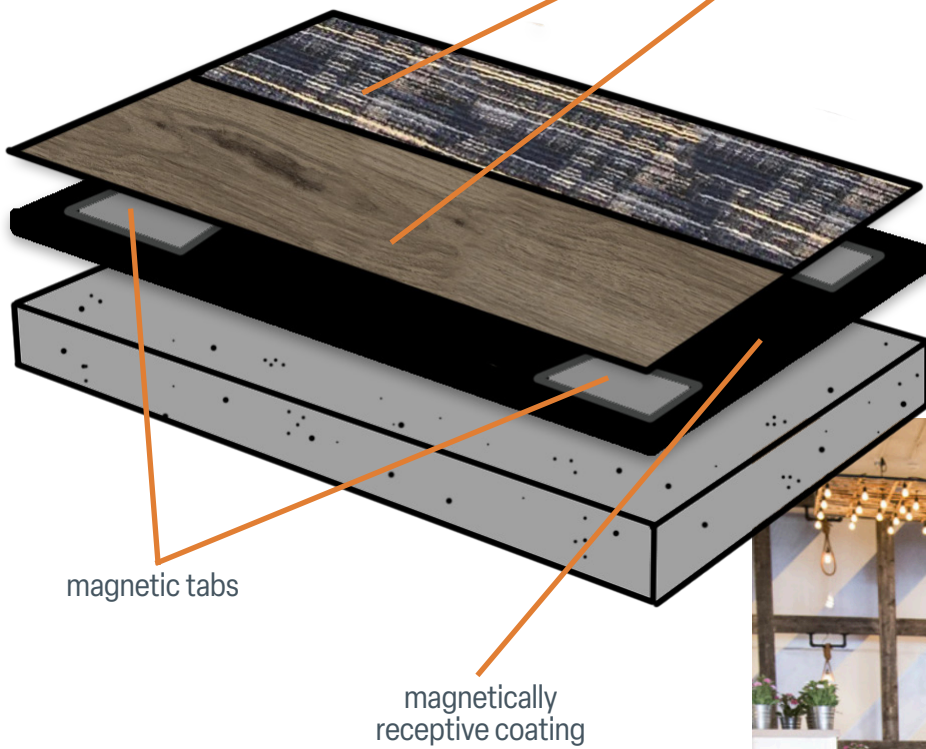

magnetic tabs

magnetically  
receptive coating

## GREAT FOR

- classrooms and hallways
- cruise lines
- hotel and event venues
- retail/sales floor
- studio and theater spaces



kretus.com/  
ecomagnetic



# ESD systems

Shield employees, equipment, and processes against harmful ESD (electrostatic discharge) with **KRETUS® TRADITIONAL ESD**. This two-coat system protects against heavy traffic, chemical spills, moisture intrusion, and microbial growth, all while maintaining its ESD properties. Based on the underlying substrate treatment, it can be installed as a high-build system with no effect on resistance readings.

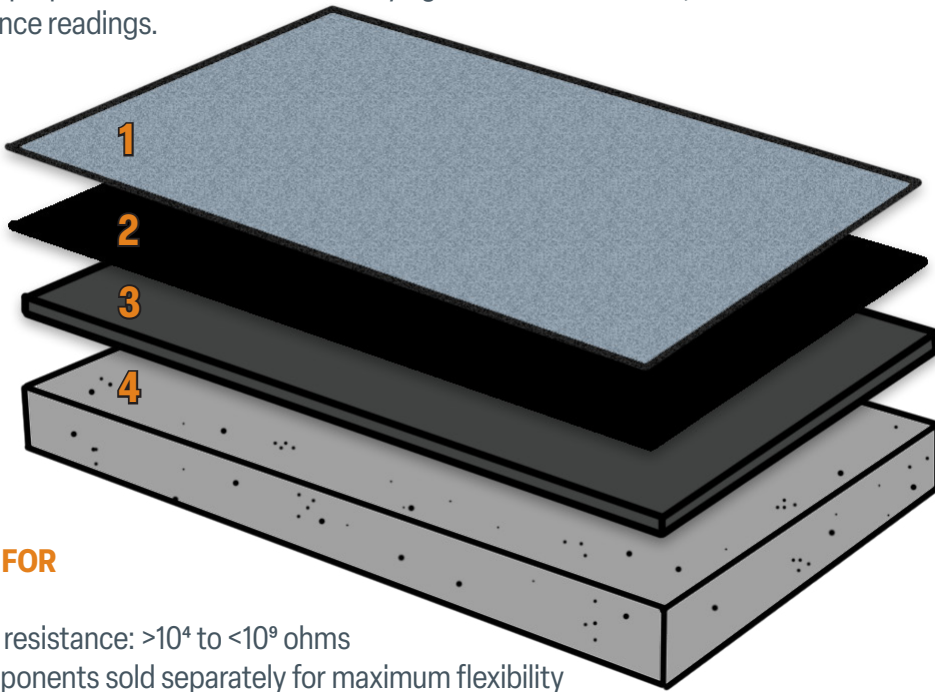

- 1** poly or epoxy ESD top coat
- 2** WB conductive primer
- 3** Kretus® system
- 4** prepared substrate

## GREAT FOR

- ESD resistance:  $>10^4$  to  $<10^9$  ohms
- components sold separately for maximum flexibility
- eleven colors
- fast- or slow-cure top coat
- UV-resistant (Poly) or economical (Epoxy) options
- strong adhesion to epoxy, urethane cement, or sand

## POPULAR COLORS

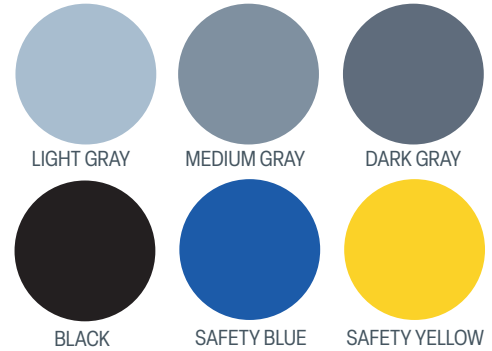

Colors shown are approximate. More options available online.

Get all the benefits of the traditional ESD system—and more—in a single application! **KRETUS® NANOTUBE ESD** incorporates carbon nanotube technology to enhance wear resistance and strengthen ESD control. Select the Epoxy for ease of installation or choose Poly for even better durability, wear resistance, and color stability.

- 1** poly or epoxy ESD top coat
- 2** Kretus® system
- 3** prepared substrate

## POPULAR COLORS



Colors shown are approximate.

## GREAT FOR

- conductive:  $>10^4$  to  $<10^6$  ohms | dissipative:  $>10^6$  to  $<10^9$  ohms
- components sold as a boxed kit for maximum control
- six colors
- UV-resistant (Poly) or economical (Epoxy) options
- strong adhesion to epoxy, urethane cement, or sand



kretus.com/  
esd

# WATERPROOFING AND



Upgrade your outdoor spaces with beautiful and low-maintenance **KRETUS® WATERPROOFING AND CONCRETE OVERLAY APC SYSTEMS**. These systems use resilient Acrylic Polymer Concrete and Acrylic Sealer to create stunning textured finishes in a variety of long-lasting colors.

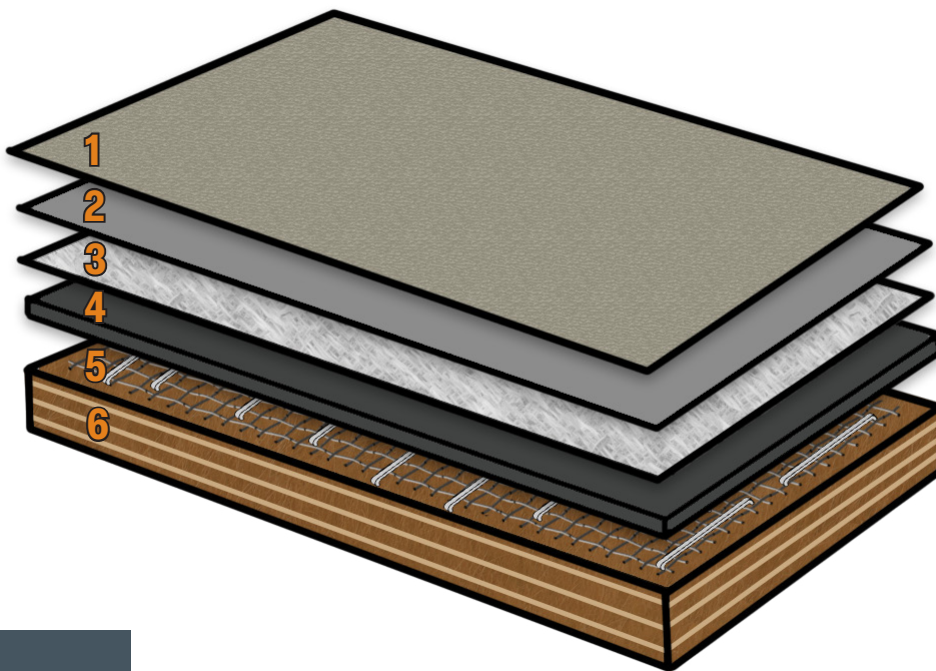

- 1 seal and texture coat
- 2 screed coat
- 3 fiberglass chopped-strand mat + bonder resin
- 4 APC acrylic admix + basecoat
- 5 metal lath + staples
- 6 plywood



# CONCRETE OVERLAY

*apc system*



**GREAT FOR**

- patios
- sidewalks
- driveways
- walking decks
- podiums and balconies



**TRENDING COLORS**



Colors shown are approximate. More options available online.



kretus.com/  
waterproofing-and-  
concrete-overlay-apc



# TOP COAT

*applications*

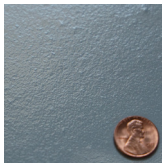

ANTI-SLIP AO 220



ANTI-SLIP AO 120

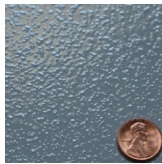

ANTI-SLIP AO 80

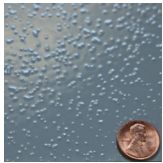

ANTI-SLIP AO 60

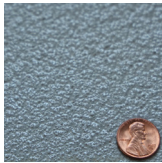

ANTI-SLIP AO 36

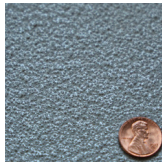

ANTI-SLIP AO 24

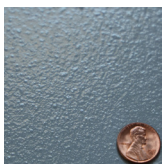

ANTI-SLIP BEAD 100

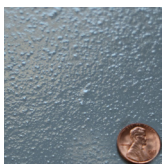

ANTI-SLIP BEAD 50/100



ANTI-SLIP BEAD 50

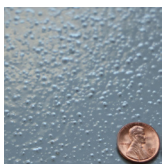

ANTI-SLIP BEAD 20/30

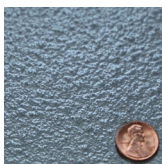

SAND 60

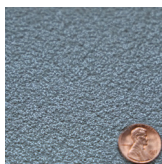

SAND 30

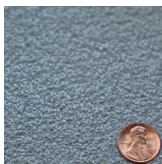

SAND 20

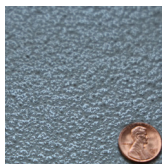

40-S

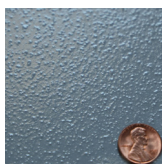

TEX 50

**KRETUS® ANTI-SLIP** and other surface texture granules increase abrasion and skid resistance and may be incorporated into any KRETUS® System. To ensure desired skid resistance is achieved, test products and systems on site within application area.



kretus.com/  
anti-slip





## KEY

NA = not applicable    X = yes    O = option available

### COMPARING TOP COATS

	Urethane Polymer Concrete	Polyurethane	Polyaspartic	Top Shelf® Epoxy	Hydrothane	Aliphatic MC	WB Acrylic Sealer	Nanotube Epoxy	Nanotube Poly
No to Low Odor	X	X		X	X		X	X	
Low to Fair Odor			X						X
Fair to High Odor						X			
UV Resistance	O	X	X		X	X	X		X
Industrial	X	X	X	X				X	X
Commercial	X	X	X	X	X	X	X		
Residential	X	X	X	X	X	X	X		
Gloss		O	X	O	O	O	O	X	X
Low Gloss	X	O		O	O	O	O		
Darkens Concrete	NA	X	X	X		X			
Color Chip		X	X	X					
Color Splash	X	X	X	X	X	X	X	X	X
Color Quartz		X	X	X	X				
Industrial Sand	X	X	X	X				X	X
Metallic		X	X	X	X	X			
APC (waterproofing)			X		X	X	X		

### COMPARING TOP COAT TEXTURES

	ANTI-SLIP							SAND	
	AO 220	AO 120	AO36	Tex 50	Bead 100	Bead 50	Bead 20/30	30	20
Industrial	X	X	X	X	X	X	X	X	X
Commercial	X	X		X	X	X	X		
Residential				X	X	X	X	X	
Color Chip				X	X	X	X		
Color Splash	X	X		X	X	X			
Color Quartz	X	X		X	X	X	X		
Industrial Sand	X	X		X	X	X	X	X	X
ESD					X	X	X		
Metallic	X			X	X	X			
Waterproofing			X	X	X	X	X	X	X

# KRĒTUS

*systems*



## GENERAL QUESTIONS

714.694.2061 | [info@kretus.com](mailto:info@kretus.com)

## TECHNICAL QUESTIONS

### ***Michael Mulnix***

Sr. Technical Product Manager, Western Territories, USA  
916.757.4075 | [michael@kretus.com](mailto:michael@kretus.com)

### ***Samet Dy***

Sr. Technical Product Manager, Eastern Territories, USA  
860.480.7980 | [samet@kretus.com](mailto:samet@kretus.com)

### ***Dennis Beshear***

Sr. Product Manager  
817.559.7591 | [dennis@kretus.com](mailto:dennis@kretus.com)

### ***Jaime Monarres***

Sr. Product Manager, Se habla Español  
424.348.5127 | [jaime@kretus.com](mailto:jaime@kretus.com)

### ***Ian Taubler***

Product Manager  
559.709.8480 | [ian@kretus.com](mailto:ian@kretus.com)

### ***Andrew Voss***

Product Manager  
920.254.2890 | [andrew@kretus.com](mailto:andrew@kretus.com)

